

America quattro SP



Parete fissa per abbinamenti

è possibile formare cabine doccia a due o tre lati, anche misure rettangolari.

Paroi fixe pour réaliser des combinaisons

pour former des parois à deux ou trois côtés, également pour des dimensions rectangulaires.

Fixed panel for combinations

to form 2 or 3 sides shower enclosures, also in rectangular sizes.

Panel fijo para combinaciones

combinaciones posibles para la formación de cabinas de ducha de dos o tres lados, también en medidas rectangulares.

Festwand für Kombinationen

mit Türen oder Eckeinstiegen, zur Gestaltung von gleich- oder ungleichschenkligen U- oder L-förmigen Duschkabinen.

Vaste wand voor samenstellingen

van twee of driezijdige douchezellen, mogelijkheid tot rechthoekige maten.

Стационарная панель для комбинирования

с душевыми кабинами. Можно создать душевые кабины с двумя или тремя сторонами, а также с прямоугольными размерами.



H 190 cm. - V 4 mm.

Finitura profili

Finitions des profilés
Profiles finishing
Acabado perfiles
Profilfarbe
Profiel afwerkingen
Отделка профилей

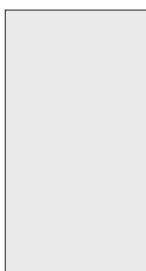

L01
bianco

blanc
white
blanco
Weiß
wit
белый



ULU
brillantato cromo

chromé brillant
brilliant chrome
aluminio cromo
Chrom glänzend
glanzend chromo
светлый блестящий хром



SAR
satinato argento

satiné argent
silver glazed satin
satinado plata
Satinierter Silber
satijn zilver
сатинированное серебро

Finitura pannelli

Finitions des panneaux
Panels finishing
Acabado perfiles
Glasart
Paneel afwerkingen
Отделка панелей

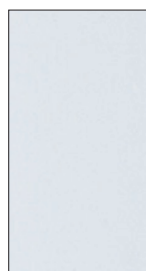

TR
trasparente

transparent
transparent
transparente
Klartglas
transparent
прозрачное

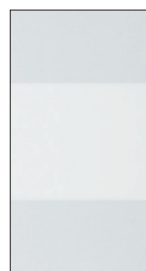

RF
trasparente con fascia Satinata

transparent bande sérigraphiée
transparent with serigraphy band
serigrafia franja
Klartglas siebdruck Band
transparent zeefdruk band
прозрачное рисунок шелкография полоса

Parete fissa per abbinamenti



Paroi fixe pour réaliser des combinaisons Fixed panel for combinations

Panel fijo para combinaciones.

Festwand für Kombinationen

Vaste wand voor samenstellingen

Стационарная панель для комбинирования

Articolo	Estensibilità Z [cm]	A [cm]	B [cm]	C [cm]	 [dm ³]	 [kg]	 [n°]
B6321	63-65	//	//	//	118	15	1
B6322	67-69	//	//	//	121	16	1
B6323	69-71	//	//	//	123	17	1
B6324	73-75	//	//	//	126	18	1
B6325	77-79	//	//	//	130	19	1
B6326	79-81	//	//	//	132	20	1
B6327	83-85	//	//	//	135	21	1
B6328	87-89	//	//	//	142	22	1
B6329	89-91	//	//	//	146	23	1

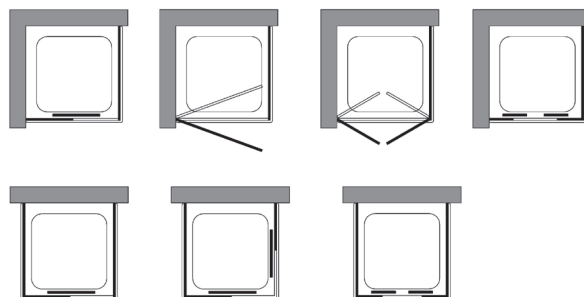
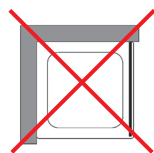
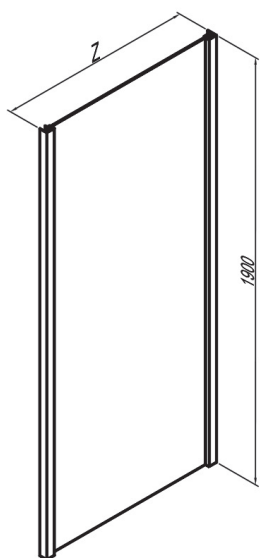

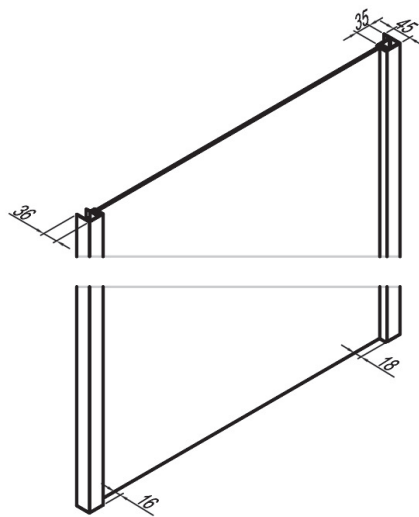
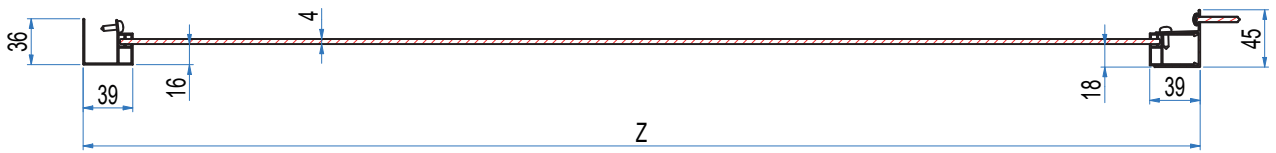



Prodotti Speciali - Produits Spéciaux - Special products - Productos Especiales - Sonderafertigungen - Maatwerk - Специальные Иродукты

MISURE LIMITE	Altezza max 200 cm.	Altezza min 50 cm.	Larghezza max 120 cm.	Larghezza min 15 cm.
MESURES LIMITES	Hauteur max 200 cm.	Hauteur min 50 cm.	Largeur max 120 cm.	Largeur min 15 cm.
LIMITS OF MEASUREMENTS	Height max 200 cm.	Height min 50 cm.	Width max 120 cm.	Width min 15 cm.
MEDIDAS LIMITE	Altura max 200 cm.	Altura min 50 cm.	Anchura max 120 cm.	Anchura min 15 cm.
GRENZMAßE	Höhe max 200 cm.	Höhe min 50 cm.	Breite max 120 cm.	Breite min 15 cm.
EXTREME MATEN	Hoogte max 200 cm.	Hoogte min 50 cm.	Breedte max 120 cm.	Breedte min 15 cm.
ПРЕДЕЛЬНЫЕ РАЗМЕРЫ:	Макс. высота 200 см	Мин. высота 50 см	Макс. ширина 120 см	Мин. ширина 15 см

	I								
	II								
	III								

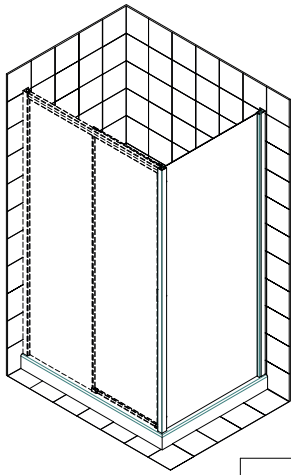

ARTICOLO	DIMENSIONI
B6321	63-65
B6322	67-69
B6323	69-71
B6324	73-75
B6325	77-79
B6326	79-81
B6327	83-85
B6328	87-89
B6329	89-91

