

Acrux



Angolo a quattro ante,

Angolo a quattro ante, apertura ad ante scorrevoli, due fisse con pannelli da 6 mm. e due apribili da 8 mm. Chiusura rallentata delle ante con sistema Soft Closing.

Paroi de douche d'angle,

Paroi de douche d'angle, ouverture par deux panneaux coulissants (mm.8) sur deux panneaux fixes (mm.6). Profilés supérieurs et verticaux portants, absence de profilé inférieur. Fermeture amortie des panneaux avec système "soft-closing". Déclipsage rapide des panneaux pour en faciliter le nettoyage.

Corner shower enclosure,

Corner shower enclosure, opening with sliding panels, two fixed (mm.6) and two can be opened (mm.8). The structure is build of vertical and top profiles, absence of bottom profiles. Slow-closing doors with "soft-closing" system. Easily detachable doors to allow a better cleaning.

Mampara de ducha angular,

Mampara de ducha angular con apertura corredera, dos hojas fijas (6 mm.) y dos correderas (8 mm.) La estructura está formada por perfiles verticales y superiores, ausencia de perfiles inferiores.

2-tlg. Eckeinstieg.

2-tlg. Eckeinstieg. 2 festen Wänden (mm. 6) und 2 Schiebetüren (mm.8). Obere und senkrechte Tragprofile, sowie dezent gehaltene Profile unten. Verlangsamte Schließung der Türen mit "soft-closing" System. Schnelllösbar der Tür zur einfachen Reinigung.

Hoekinstap met vier panelen,

Hoekinstap met vier panelen, twee schuivende panelen van 8 mm. veiligheidsglas en twee vaste panelen van 6 mm. veiligheidsglas. Dragende verticale en bovenliggende profielen, profielloos onderaan. Fermeture amortie des panneaux avec système "soft-closing". Gemakkelijk afneembaar deuren naar een betere reiniging mogelijk te maken.

Угловая конструкция с четырехстворчатыми дверьми,

Угловая конструкция с четырехстворчатыми дверьми, открывание при помощи раздвижных створок, две стационарные толщиной 6 мм, две открываемые толщиной 8 мм. Несущие верхние и вертикальные профили, нижние отсутствуют. Легко съемные двери, чтобы позволить лучшую очистку. Медленное открытие дверей с "soft-closing" закрытия системы.



H 200 cm. - V 6/8 mm.

Profili in alluminio / Finitions profilés en aluminium / Profiles finishing / Acabado perfiles / Glasart / Afwerking panelen veiligheidsglas / Отделка панелей из закаленного стекла



ULU
Brillantato cromo / Chromé brillant / Brilliant chrome / Cromo brillante / Satiniert silber / Glanzend chroom / сатинированное серебро

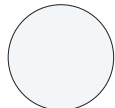

L90
Artico opaco / Artico mat / Artico / Artico / Artico / Artico mat / artico



L92
Sailor blue opaco / Sailor blue mat / Sailor blue / Sailor blue / Sailor Blue / Sailor blue mat / Sailor blue



L96
Nero opaco / Noir mat / Black / Negro / Schwarz / Zwart mat / черный

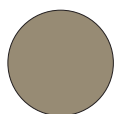

L99
Tortora opaco / Tortora mat / Tortora / Tortora / Satijn zilver / tortora mat / tortora

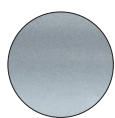

SAR
Satinato Argento / satiné argent / silver glazed satin / satinado plata / Satiniert silber / satijn zilver / светлый блестящий хром

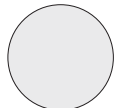

L91
Bianco opaco / Blanc mat / White / Blanco / Weiß / Wit mat / белый

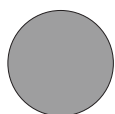

L95
Grigio opaco / Gris mat / Grey / Gris / Grau / Grijs mat / серый

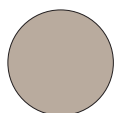

L98
Sabbia opaco / Sable mat / Sand / Arena / Sand / zandkleur mat / песок

Finitura profili / Finitions des profilés / Profiles finishing / Acabado perfiles / Profilfarbe / Profiel afwerkingen / Отделка профилей

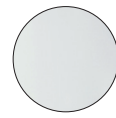

TR
Trasparente / Transparent / Transparent / Transparente / Klarglas / Transparent / прозрачное



TG
Trasparente grigio / Transparent Gris / Transparent Grey / Transparente gris / Klarglas Grau / Transparent Grijs / серое прозрачное

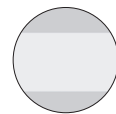

RF
Trasparente con fascia satinata H 100 cm / Transparent avec bande sérigraphiée H. 100 cm. / transparent serigraphy band / Cristal de espejo / Klarglas siebdruck Band / transparent met zeefdruk band H. 100 cm / прозрачное рисунок шелкография полоса H. 100 cm.

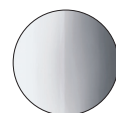

SY
Vetro a specchio / Verre miroir uniquement sur les panneaux fixes, les panneaux coulissants restent TR / Mirrored glass / transparente serigrafia franja / Spiegelglas / Spiegelend glas / стекло зеркало на неподвижных панелях, скользящих панелях TR

Angolo a quattro ante

Accès d'angle à quatre panneaux

Corner shower enclosure

Angular corredera

2-tlg Eckeinstieg

Hoekinstap met vier panelen

Угловая конструкция с четырехстворчатыми дверьми



Trattamento anticalcare di serie compreso nel prezzo
Traitement anti-calcaire inclus dans le prix
Anti-limescale treatment included in the price
Tratamiento antical incluido en el precio
Gegen Kalkablagerungen schützende Glasbehandlung im Preis inbegriffen
Anti-kalkafwerking inbegrepen in de prijs
Средство от известкового налета включено в цену

Z [cm]	Cod	A [cm]	B [cm]	C [cm]	[dm ³]	[kg]	[n°]
67-69	B8816	32	33,3	36	80	29	1
72-74	B8817	34,5	35,8	40	83	32	1
77-79	B8818	37	38,3	43	87	34	1
87-89	B8820	42	43,3	50	97	37	1
97-99	B8821	52	43,3	51	101	40	1
107-109	B8832	62	43,3	51	106	43	1
117-119	B8833	72	43,3	51	123	46	1

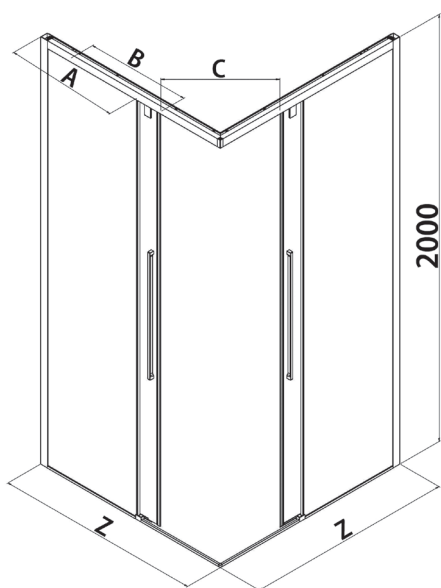

samo

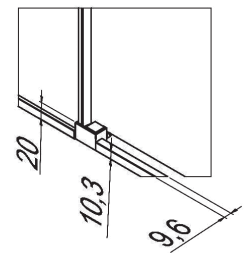
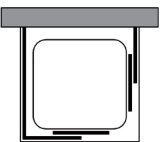
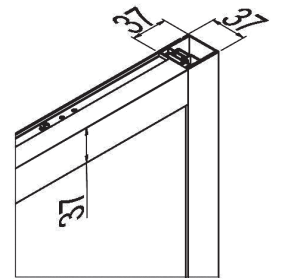
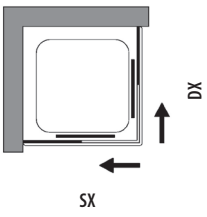
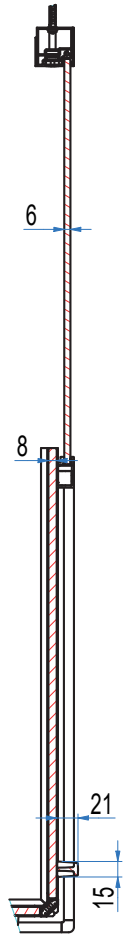
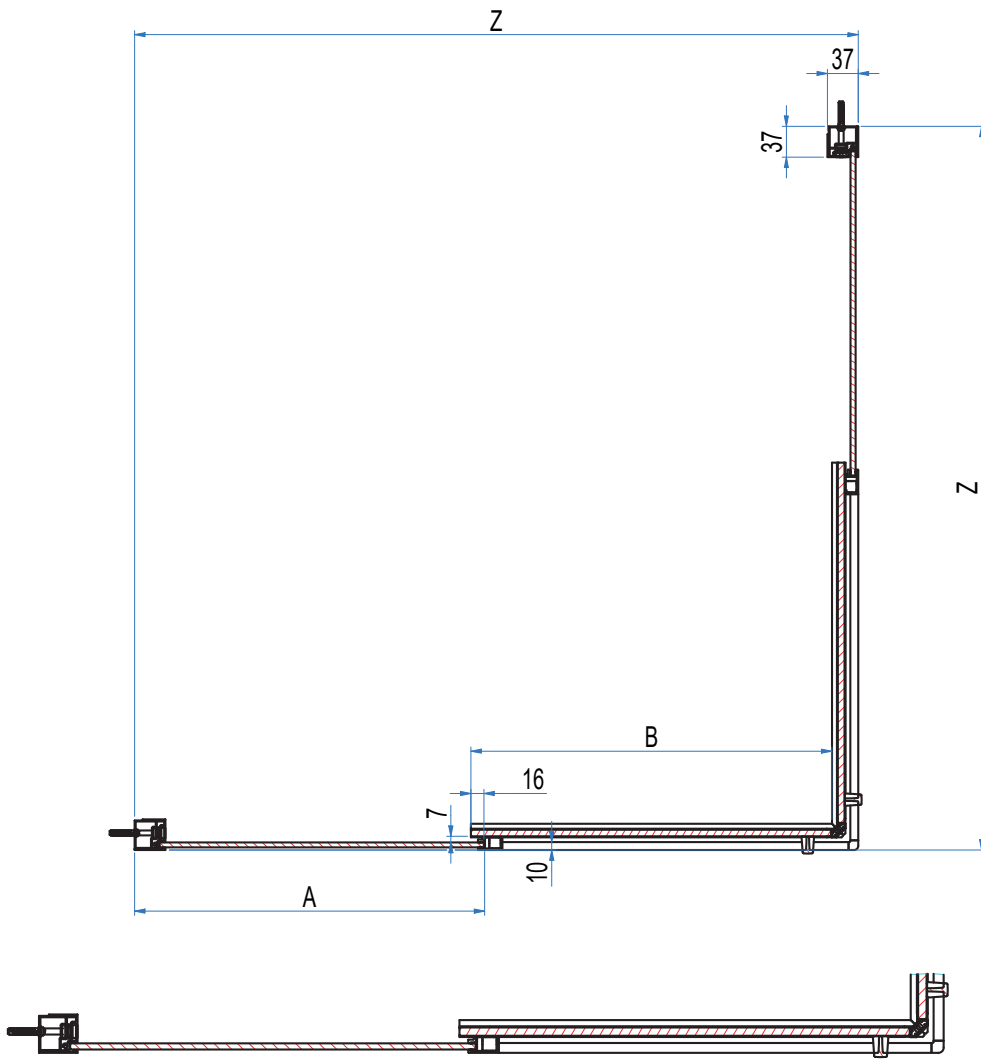



Prodotti Speciali - Produits Spéciaux - Special products - Productos Especiales - Sonderfertigungen - Maatwerk - Специальные Иродукты

MISURE LIMITE	Altezza max 210 cm.	Larghezza max 120 cm.	Larghezza min 60 cm.	
MESURES LIMITES	Hauteur max 210 cm.	Largeur max 120 cm.	Largeur min 60 cm.	
LIMITS OF MEASUREMENTS	Height max 210 cm.	Width max 120 cm.	Width min 60 cm.	
MEDIDAS LIMITE	Altura max 210 cm.	Anchura max 120 cm.	Anchura min 60 cm.	
GRENZMAßE	Höhe max 210 cm.	Breite max 120 cm.	Breite min 60 cm.	
EXTREME MATEN	Hoogte max 210 cm.	Breedte max 120 cm.	Breedte min 60 cm.	
ПРЕДЕЛЬНЫЕ РАЗМЕРЫ:	Макс. высота 210 см	Макс. ширина 120 см	Мин. ширина 60 см	

	I								
	II								
	III								

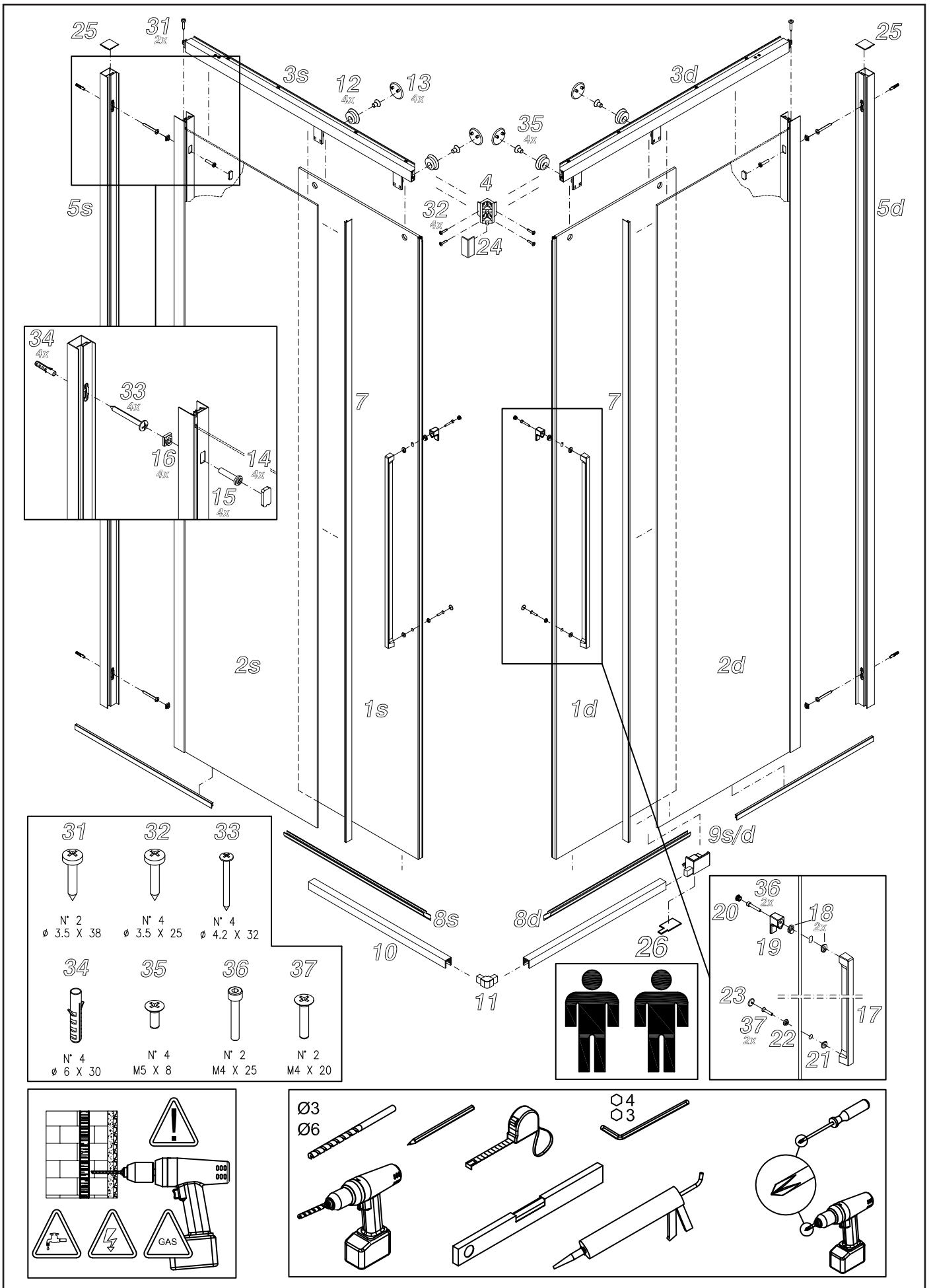

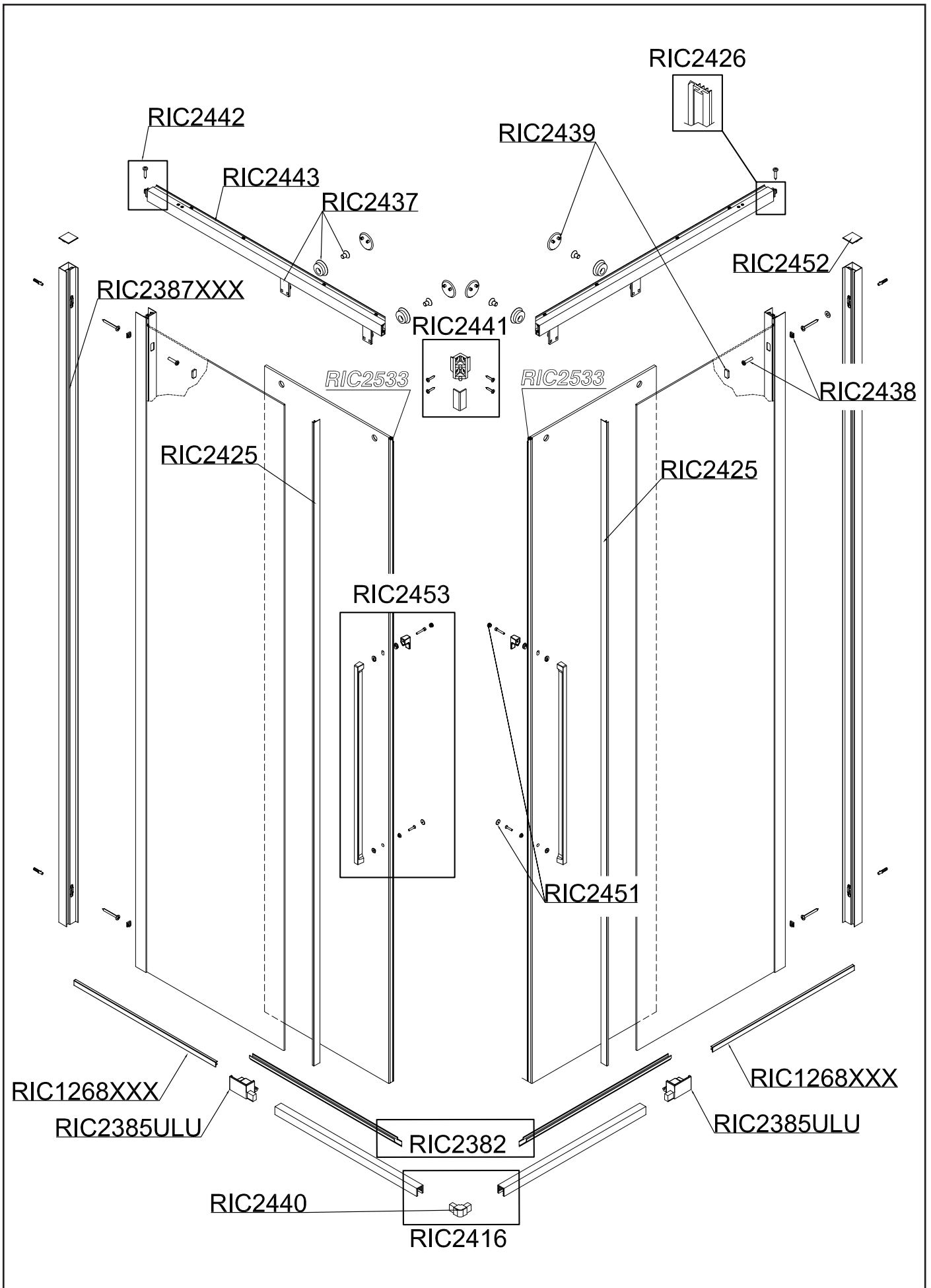

<p>RIC2387XXX</p> <p>1x</p>	<p>RIC2425</p> <p>1x (sx) 1x (dx)</p>	<p>RIC2426</p> <p>1x</p>	<p>RIC2533</p> <p>1x 1x 1x</p>
<p>RIC2452</p> <p>2x</p>	<p>RIC2385ULU</p> <p>1x (sx) 1x (dx)</p>	<p>RIC2441</p> <p>1x 1x 1x Ø 4.2 X 32</p>	<p>RIC2442</p> <p>2x 2x Ø 3,5 X 32 4x Ø 3,5 X 38</p>
<p>RIC2440</p> <p>1x</p>	<p>RIC2439</p> <p>4x 4x</p>	<p>RIC2382</p> <p>1x (sx) 1x (dx)</p>	<p>RIC2416XXX</p> <p>2x 1x</p>
<p>RIC2451</p> <p>1x 1x</p>	<p>RIC2453</p> <p>2x 1x 1x 1x</p>	<p>RIC2443</p> <p>1x</p>	<p>RIC2455</p> <p>1x 2x 1x 1x 1x 1x</p>
<p>RIC2453</p> <p>1x</p>	<p>RIC1268XXX</p> <p>1x</p>	<p>RIC2438</p> <p>6x 6x</p>	<p>RIC2444</p> <p>1x</p>
<p>RIC2437</p> <p>2x</p>	<p>RIC2443</p> <p>1x</p>	<p>RIC2443</p> <p>1x</p>	<p>RIC2443</p> <p>1x</p>
<p>RIC2437</p> <p>2x</p>	<p>RIC2444</p> <p>1x</p>	<p>RIC2443</p> <p>1x</p>	<p>RIC2443</p> <p>1x</p>
<p>RIC2437</p> <p>2x</p>	<p>RIC2444</p> <p>1x</p>	<p>RIC2443</p> <p>1x</p>	<p>RIC2443</p> <p>1x</p>
<p>RIC2437</p> <p>2x</p>	<p>RIC2444</p> <p>1x</p>	<p>RIC2443</p> <p>1x</p>	<p>RIC2443</p> <p>1x</p>
<p>RIC2437</p> <p>2x</p>	<p>RIC2444</p> <p>1x</p>	<p>RIC2443</p> <p>1x</p>	<p>RIC2443</p> <p>1x</p>
<p>RIC2437</p> <p>2x</p>	<p>RIC2444</p> <p>1x</p>	<p>RIC2443</p> <p>1x</p>	<p>RIC2443</p> <p>1x</p>
<p>RIC2437</p> <p>2x</p>	<p>RIC2444</p> <p>1x</p>	<p>RIC2443</p> <p>1x</p>	<p>RIC2443</p> <p>1x</p>
<p>RIC2437</p> <p>2x</p>	<p>RIC2444</p> <p>1x</p>	<p>RIC2443</p> <p>1x</p>	<p>RIC2443</p> <p>1x</p>
<p>RIC2437</p> <p>2x</p>	<p>RIC2444</p> <p>1x</p>	<p>RIC2443</p> <p>1x</p>	<p>RIC2443</p> <p>1x</p>
<p>RIC2437</p> <p>2x</p>	<p>RIC2444</p> <p>1x</p>	<p>RIC2443</p> <p>1x</p>	<p>RIC2443</p> <p>1x</p>
<p>RIC2437</p> <p>2x</p>	<p>RIC2444</p> <p>1x</p>	<p>RIC2443</p> <p>1x</p>	<p>RIC2443</p> <p>1x</p>
<p>RIC2437</p> <p>2x</p>	<p>RIC2444</p> <p>1x</p>	<p>RIC2443</p> <p>1x</p>	<p>RIC2443</p> <p>1x</p>
<p>RIC2437</p> <p>2x</p>	<p>RIC2444</p> <p>1x</p>	<p>RIC2443</p> <p>1x</p>	<p>RIC2443</p> <p>1x</p>
<p>RIC2437</p> <p>2x</p>	<p>RIC2444</p> <p>1x</p>	<p>RIC2443</p> <p>1x</p>	<p>RIC2443</p> <p>1x</p>
<p>RIC2437</p> <p>2x</p>	<p>RIC2444</p> <p>1x</p>	<p>RIC2443</p> <p>1x</p>	<p>RIC2443</p> <p>1x</p>
<p>RIC2437</p> <p>2x</p>	<p>RIC2444</p> <p>1x</p>	<p>RIC2443</p> <p>1x</p>	<p>RIC2443</p> <p>1x</p>
<p>RIC2437</p> <p>2x</p>	<p>RIC2444</p> <p>1x</p>	<p>RIC2443</p> <p>1x</p>	<p>RIC2443</p> <p>1x</p>
<p>RIC2437</p> <p>2x</p>	<p>RIC2444</p> <p>1x</p>	<p>RIC2443</p> <p>1x</p>	<p>RIC2443</p> <p>1x</p>
<p>RIC2437</p> <p>2x</p>	<p>RIC2444</p> <p>1x</p>	<p>RIC2443</p> <p>1x</p>	<p>RIC2443</p> <p>1x</p>
<p>RIC2437</p> <p>2x</p>	<p>RIC2444</p> <p>1x</p>	<p>RIC2443</p> <p>1x</p>	<p>RIC2443</p> <p>1x</p>
<p>RIC2437</p> <p>2x</p>	<p>RIC2444</p> <p>1x</p>	<p>RIC2443</p> <p>1x</p>	<p>RIC2443</p> <p>1x</p>
<p>RIC2437</p> <p>2x</p>	<p>RIC2444</p> <p>1x</p>	<p>RIC2443</p> <p>1x</p>	<p>RIC2443</p> <p>1x</p>
<p>RIC2437</p> <p>2x</p>	<p>RIC2444</p> <p>1x</p>	<p>RIC2443</p> <p>1x</p>	<p>RIC2443</p> <p>1x</p>
<p>RIC2437</p> <p>2x</p>	<p>RIC2444</p> <p>1x</p>	<p>RIC2443</p> <p>1x</p>	<p>RIC2443</p> <p>1x</p>
<p>RIC2437</p> <p>2x</p>	<p>RIC2444</p> <p>1x</p>	<p>RIC2443</p> <p>1x</p>	<p>RIC2443</p> <p>1x</p>
<p>RIC2437</p> <p>2x</p>	<p>RIC2444</p> <p>1x</p>	<p>RIC2443</p> <p>1x</p>	<p>RIC2443</p> <p>1x</p>
<p>RIC2437</p> <p>2x</p>	<p>RIC2444</p> <p>1x</p>	<p>RIC2443</p> <p>1x</p>	<p>RIC2443</p> <p>1x</p>
<p>RIC2437</p> <p>2x</p>	<p>RIC2444</p> <p>1x</p>	<p>RIC2443</p> <p>1x</p>	<p>RIC2443</p> <p>1x</p>
<p>RIC2437</p> <p>2x</p>	<p>RIC2444</p> <p>1x</p>	<p>RIC2443</p> <p>1x</p>	<p>RIC2443</p> <p>1x</p>
<p>RIC2437</p> <p>2x</p>	<p>RIC2444</p> <p>1x</p>	<p>RIC2443</p> <p>1x</p>	<p>RIC2443</p> <p>1x</p>
<p>RIC2437</p> <p>2x</p>	<p>RIC2444</p> <p>1x</p>	<p>RIC2443</p> <p>1x</p>	<p>RIC2443</p> <p>1x</p>
<p>RIC2437</p> <p>2x</p>	<p>RIC2444</p> <p>1x</p>	<p>RIC2443</p> <p>1x</p>	<p>RIC2443</p> <p>1x</p>
<p>RIC2437</p> <p>2x</p>	<p>RIC2444</p> <p>1x</p>	<p>RIC2443</p> <p>1x</p>	<p>RIC2443</p> <p>1x</p>
<p>RIC2437</p> <p>2x</p>	<p>RIC2444</p> <p>1x</p>	<p>RIC2443</p> <p>1x</p>	<p>RIC2443</p> <p>1x</p>
<p>RIC2437</p> <p>2x</p>	<p>RIC2444</p> <p>1x</p>	<p>RIC2443</p> <p>1x</p>	<p>RIC2443</p> <p>1x</p>
<p>RIC2437</p> <p>2x</p>	<p>RIC2444</p> <p>1x</p>	<p>RIC2443</p> <p>1x</p>	<p>RIC2443</p> <p>1x</p>
<p>RIC2437</p> <p>2x</p>	<p>RIC2444</p> <p>1x</p>	<p>RIC2443</p> <p>1x</p>	<p>RIC2443</p> <p>1x</p>
<p>RIC2437</p> <p>2x</p>	<p>RIC2444</p> <p>1x</p>	<p>RIC2443</p> <p>1x</p>	<p>RIC2443</p> <p>1x</p>
<p>RIC2437</p> <p>2x</p>	<p>RIC2444</p> <p>1x</p>	<p>RIC2443</p> <p>1x</p>	<p>RIC2443</p> <p>1x</p>
<p>RIC2437</p> <p>2x</p>	<p>RIC2444</p> <p>1x</p>	<p>RIC2443</p> <p>1x</p>	<p>RIC2443</p> <p>1x</p>
<p>RIC2437</p> <p>2x</p>	<p>RIC2444</p> <p>1x</p>	<p>RIC2443</p> <p>1x</p>	<p>RIC2443</p> <p>1x</p>
<p>RIC2437</p> <p>2x</p>	<p>RIC2444</p> <p>1x</p>		