

RIC1806

2x

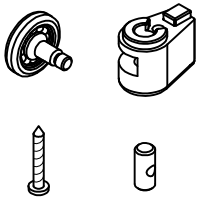

RIC1807

2x

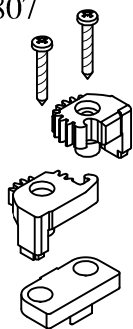

RIC1800

~x ?



RIC1805

2x

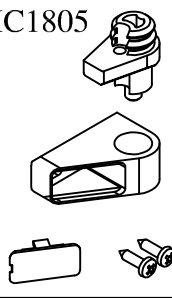

RIC2235

2x

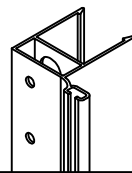

RIC2248

RIC2768

RIC2249

RIC2770

RIC2250

RIC2772

RIC2251

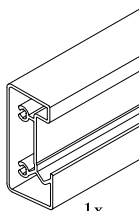

1x

RIC2233

2x

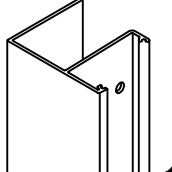

RIC1808

1x

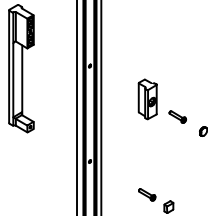

RIC1798

2x



RIC1364

2x

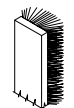

RIC1731

2x



RIC2252

RIC2269

RIC2253

RIC2271

RIC2254

RIC2273

RIC2255

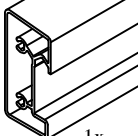

1x

*RIC2233*

1x

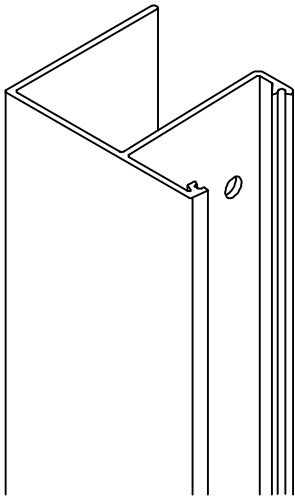

*RIC1731*

2x

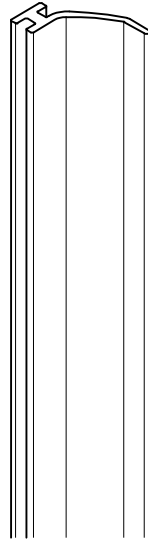

*RIC1798*

2x

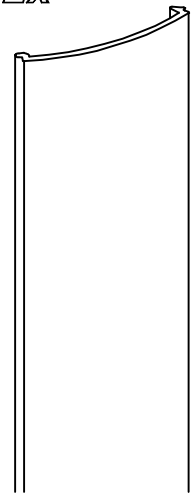

*RIC1807*

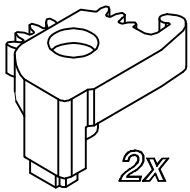

2x

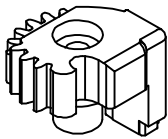

2x

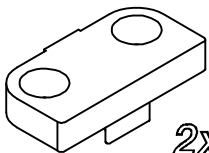

2x

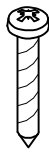
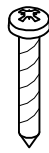

2x

*RIC1805*

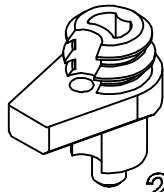

2x

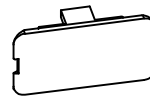

2x



2x

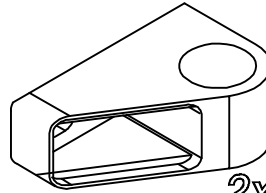

2x

*RIC1800*

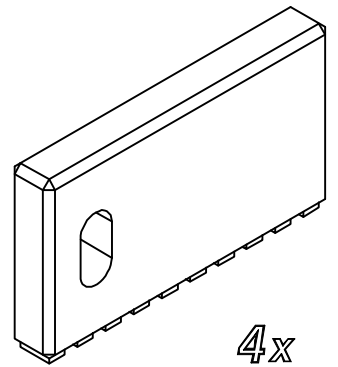

4x

*RIC1806*

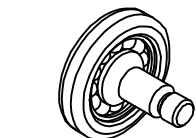

2x

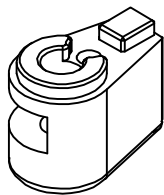

2x

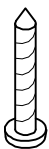

2x



2x

*RIC1808*

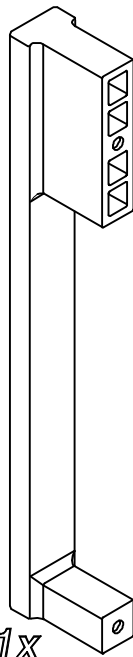

1x

1x

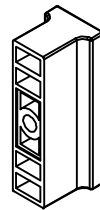

1x



2x



1x



1x



1x



1x



*RIC1799*

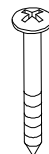

6x



*RIC1364*

2x

