



**Angolo a quattro ante,**  
apertura ad ante scorrevoli, due fisse e due apribili. Profili superiori e verticali portanti, assenza di quelli inferiori.

**Paroi de douche d'angle,**  
ouverture par deux panneaux coulissants sur deux panneaux fixes.

**Corner shower enclosure,**  
opening with sliding panels, two fixed and two can be opened.

**Mampara de ducha angular,**  
con dos hojas fijas y dos correderas. La estructura está formada de perfiles verticales y superiores, ausencia de perfiles inferiores.

**2-tlg. Eckeinstieg,**  
2 festen Wänden und 2 Schiebetüren.

**Hoekinstap met twee schuivende panelen,**  
en twee vaste panelen.

**Четырехстворчатая угловая конструкция,**  
центральное открытие при помощи раздвижных створок: две стационарные и две открывающиеся. Несущие верхний и вертикальные профили, нижние отсутствуют.



**H 195 cm. - V 6 mm.**

## Finitura profili

Finitions des profilés\_Profiles finishing \_Acabado perfiles  
Profilfarbe\_Profiel afwerkingen \_Отделка профилей

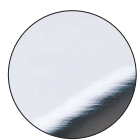

**ULU**  
**brillantato cromo**  
chromé brillant  
brilliant chrome  
aluminio cromo  
Chrom glänzend  
glanzend chroom  
светлый блестящий хром



**L01**  
**bianco**  
blanc  
white  
blanco  
Weiß  
wit  
белый



**SAR**  
**satinato argento**  
satiné argent  
silver glazed satin  
satinado plata  
Satinier Silber  
satijn Zilver  
сатинированное серебро

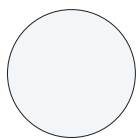

**L91**  
**bianco opaco**  
blanc mat  
matt white  
blanco mate  
Matt Weiß  
wit matte  
белый Матовая

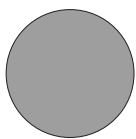

**L95**  
**grigio opaco**  
gris mat  
matt grey  
gris mate  
Matt Grau  
grijs matte  
серый Матовая



**L96**  
**nero opaco**  
noir mat  
matt black  
negro mate  
Matt Schwarz  
zwart matte  
черный Матовая

## Finitura pannelli

Finitions des panneaux\_Panels finishing \_Acabado perfiles  
Glasart\_Panel afwerkingen \_Отделка панелей



**TR**  
**trasparente**  
transparent  
transparent  
transparente  
Klarglas  
transparent  
прозрачное



**ST**  
**Stampato**  
granité  
frosted  
estampado  
Bedrucktes Glas  
gemarteld  
узорчатое

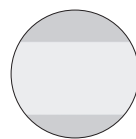

**RF**  
**trasparente con fascia Satinata**  
transparent bande sérigraphiée  
transparent with serigraphy band  
serigrafia franja  
Klarglas siebdruck Band  
transparent zeefdruk band  
прозрачное рисунок шелкография полоса

# Angolo scorrevole a quattro ante

Accès d'angle



Corner shower enclosure

Angular de dos hojas correderas

2-tlg. Ekeinstieg

Hoekinstap met vier panelen

Четырехстворчатая угловая конструкция

Z [cm]	Cod.	A [cm]	B [cm]	C [cm]	 [dm <sup>3</sup> ]	 [kg]	 [n°]
67-69	B0916	30,6-32,6	34,3	35	112	26	1
70-72	B0914	31,1-33,6	36,8	39	115	28	1
72-74	B0917	33,1-35,1	36,8	39	122	28	1
75-77	B0915	33,6-35,6	39,3	42	124	30	1
77-79	B0918	35,6-37,6	39,3	42	130	30	1
80-82	B0919	37,1-39,1	40,8	45	136	30	1
87-89	B0920	40,6-42,6	44,3	49	144	35	1
90-92	B0922	42,1-44,1	45,8	52	152	35	1
97-99	B0921	45,6-47,6	49,3	56	160	38	1
117-119	B0923	65,6-67,6	49,3	56	175	41	1

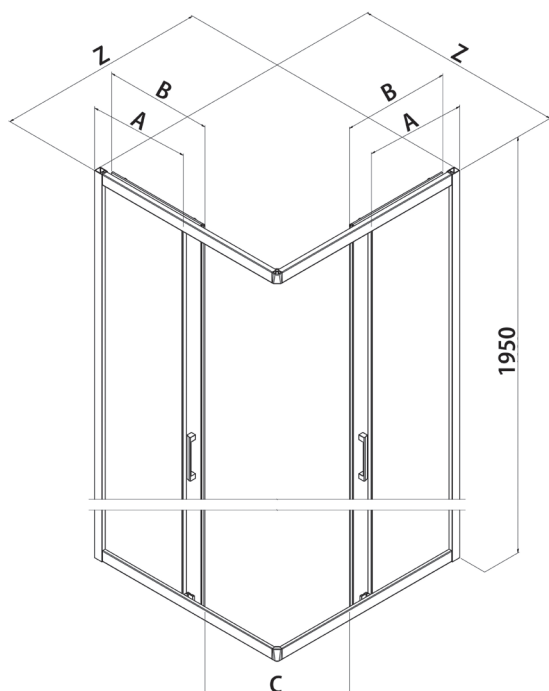

**160 mm**

Interasse maniglia  
Empattement de la poignée  
Handle wheelbase  
Distancia entre ejes de la manija  
Radstand handhaben  
Handvat wielbasis  
Колесная база ручки

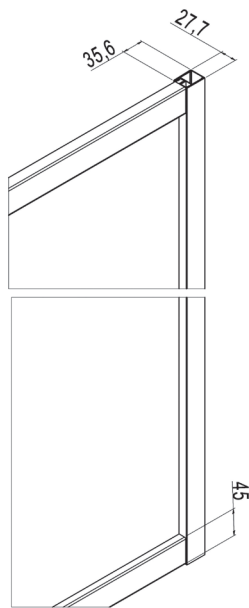
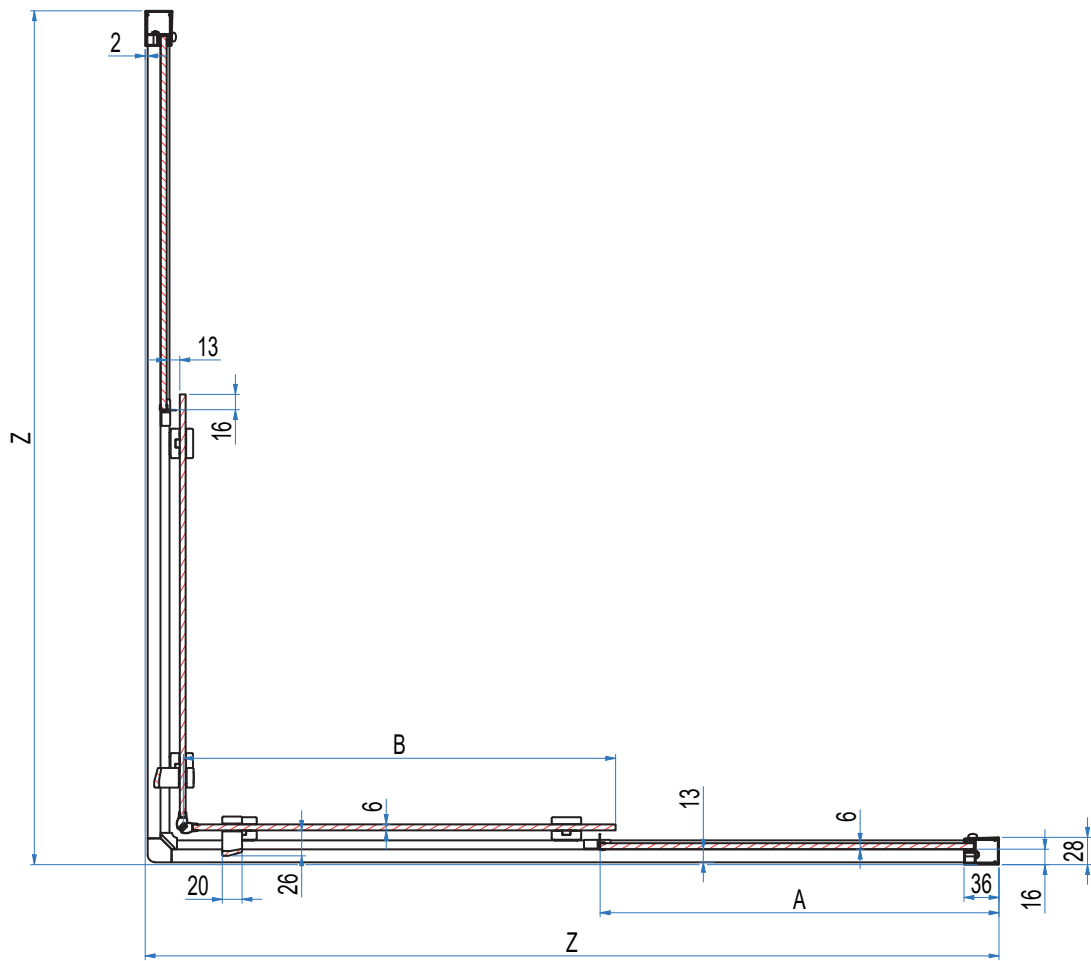



Prodotti Speciali - Produits Spéciaux - Special products - Productos Especiales - Sonderfertigungen - Maatwerk - Специальные Иродукты

MISURE LIMITE	Altezza max 200 cm.	//	Larghezza max 130 cm.	Larghezza min 50 cm.
MESURES LIMITES	Hauteur max 200 cm.	//	Largeur max 130 cm.	Largeur min 50 cm.
LIMITS OF MEASUREMENTS	Height max 200 cm.	//	Width max 130 cm.	Width min 50 cm.
MEDIDAS LIMITE	Altura max 200 cm.	//	Anchura max 130 cm.	Anchura min 50 cm.
GRENZMAßE	Höhe max 200 cm.	//	Breite max 130 cm.	Breite min 50 cm.
EXTREME MATEN	Hoogte max 200 cm.	//	Breedte max 130 cm.	Breedte min 50 cm.
ПРЕДЕЛЬНЫЕ РАЗМЕРЫ:	Макс. высота 200 см	//	Макс. ширина 130 см	Мин. ширина 50 см

	I								
	II								
	III								

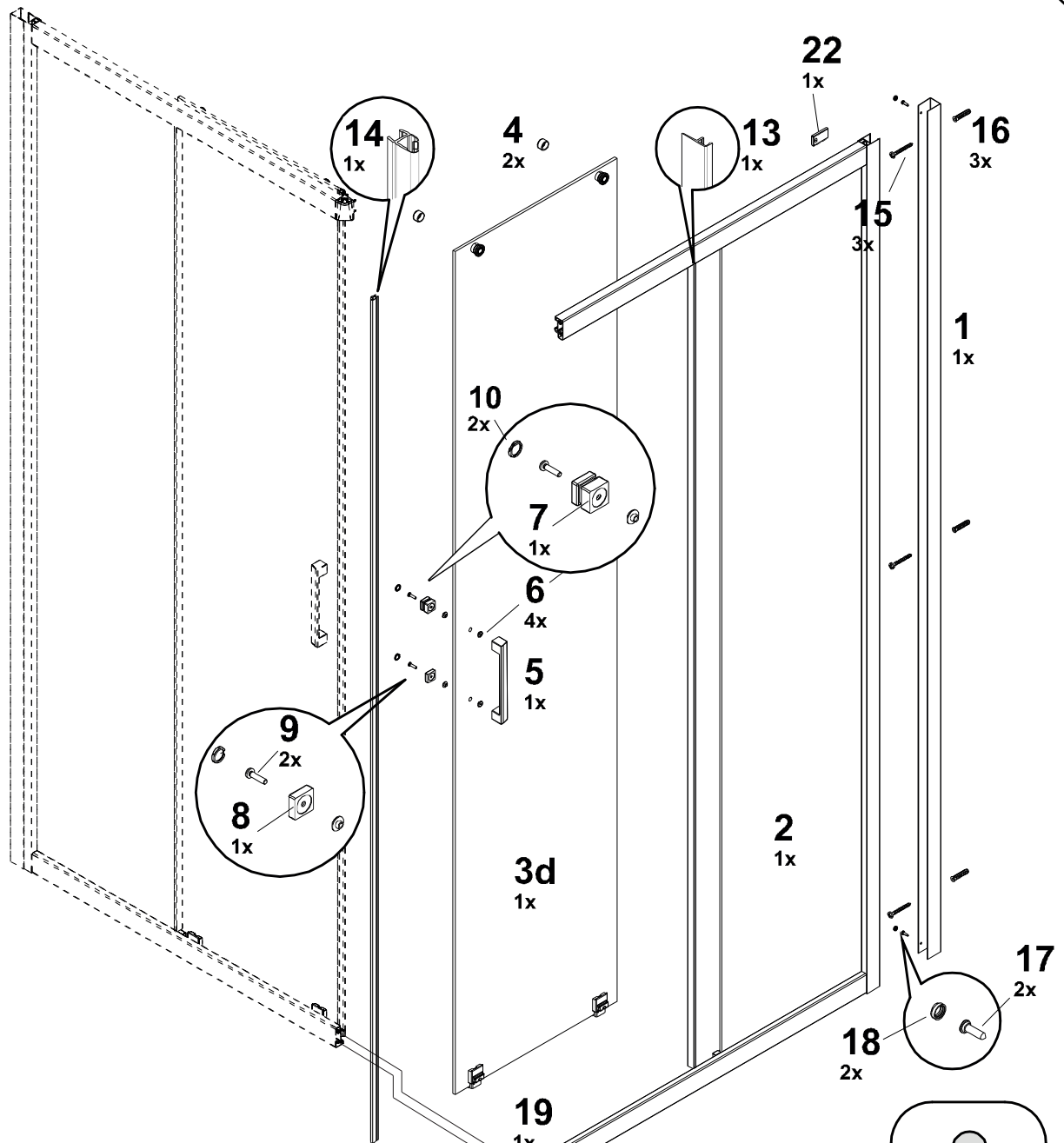

- |               |                |                 |                 |                 |
|---------------|----------------|-----------------|-----------------|-----------------|
|               |                |                 |                 |                 |
| N°3<br>ø 6x30 | N°2<br>ø M4x16 | N°3<br>ø 3.9x38 | N°2<br>ø 3.9x13 | N°4<br>ø 3.9x25 |

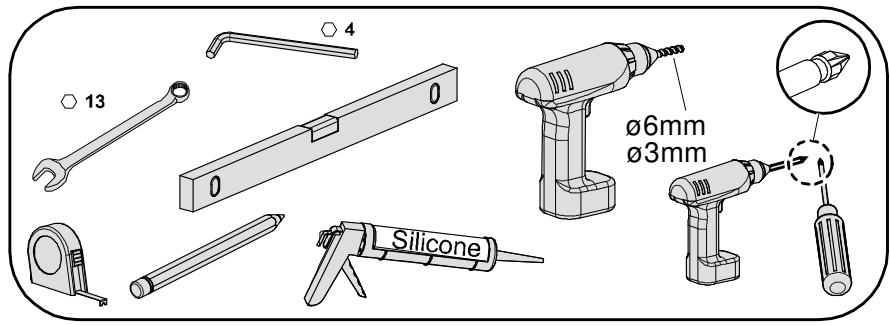
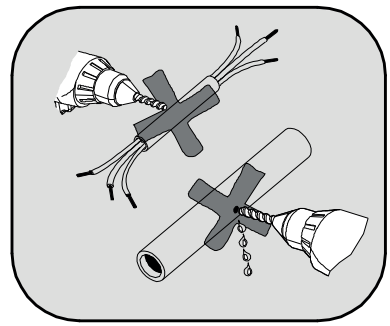
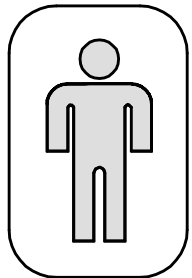

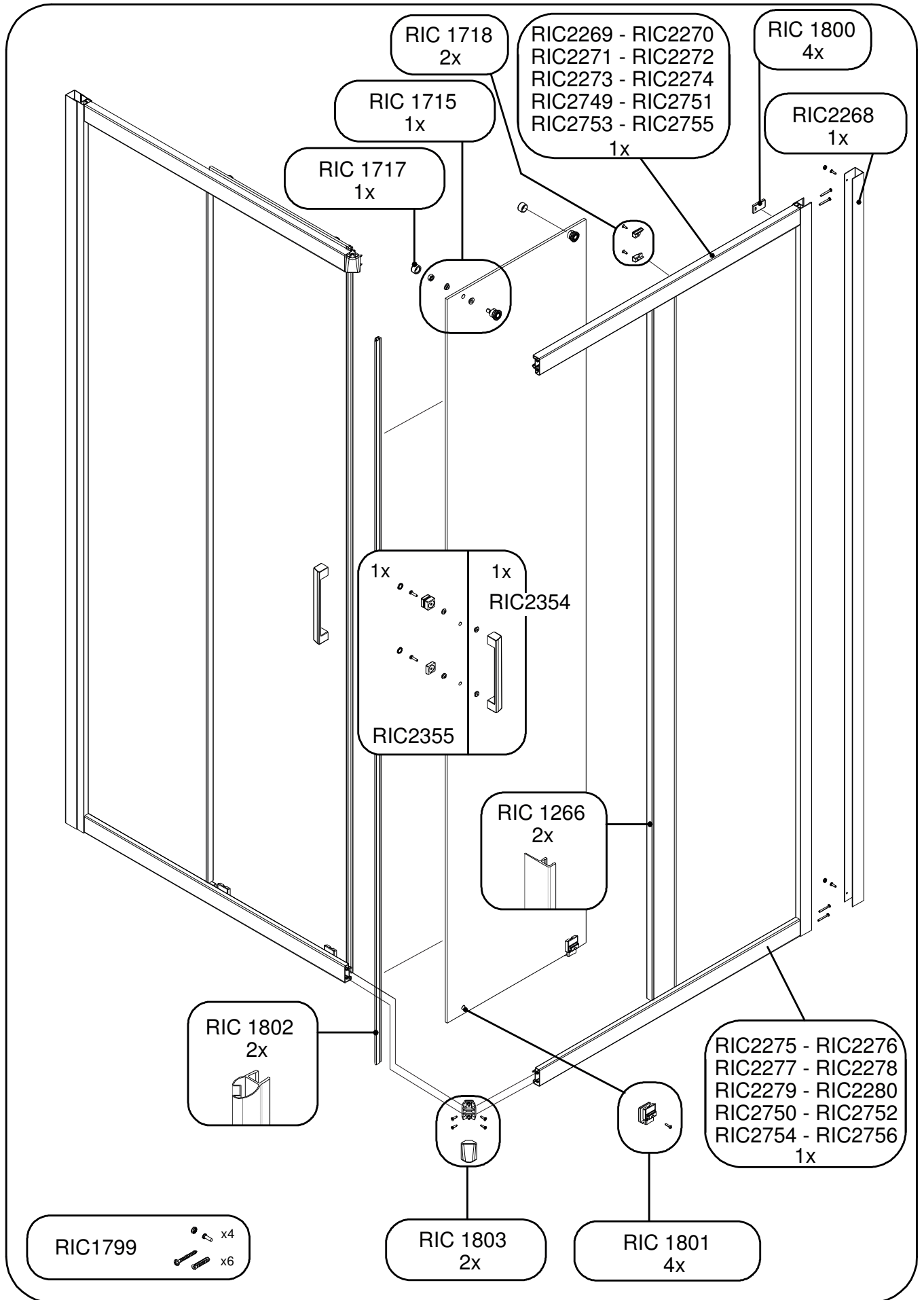

**RIC 1799**

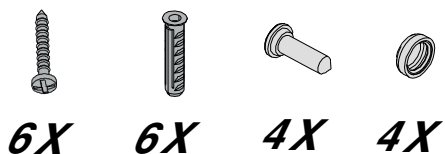

**6X 6X 4X 4X**

**RIC 1266**



**2X**

**RIC 1802**

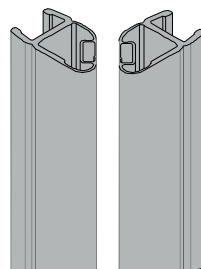

**2X**

- RIC 2275\_\_ - B0916**
- RIC 2276\_\_ - B0917**
- RIC 2277\_\_ - B0918**
- RIC 2278\_\_ - B0920**
- RIC 2279\_\_ - B0921**
- RIC 2280\_\_ - B0923**
- RIC 2750\_\_ - B0914**
- RIC 2752\_\_ - B0915**
- RIC 2754\_\_ - B0919**
- RIC 2756\_\_ - B0922**

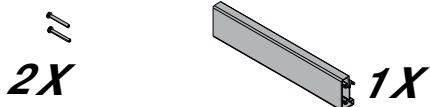

- RIC 2269\_\_ - B0916**
- RIC 2270\_\_ - B0917**
- RIC 2271\_\_ - B0918**
- RIC 2272\_\_ - B0920**
- RIC 2273\_\_ - B0921**
- RIC 2274\_\_ - B0923**
- RIC 2749\_\_ - B0914**
- RIC 2751\_\_ - B0915**
- RIC 2753\_\_ - B0919**
- RIC 2755\_\_ - B0922**

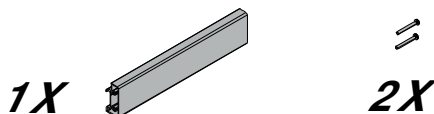

**RIC 2268**

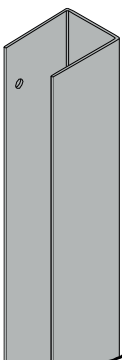

**1X**

**RIC 2354**

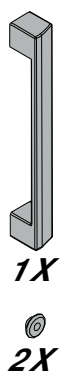

**1X 2X**

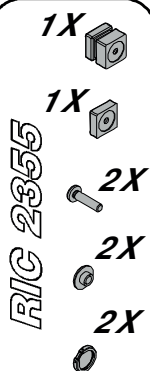

**1X 1X 2X 2X 2X**

**RIC 1800**

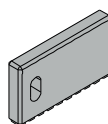

**2X**

**RIC 1718**

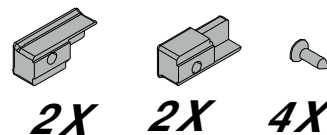

**2X 2X 4X**

**RIC 1803**

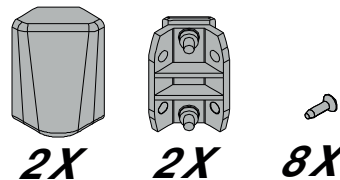

**2X 2X 8X**

**RIC 1715**

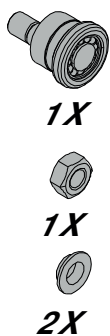

**1X 1X 1X 2X**

**RIC 1717**



**4X**

**RIC 1801**

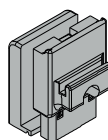

**4X**



**4X**

**RIC 1128**

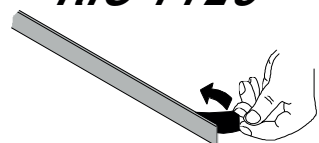

**1X**