

America



Parete fissa per abbinamenti
è possibile formare cabine doccia a due o tre lati, anche misure rettangolari.

Paroi fixe pour réaliser des combinaisons
pour former des parois à deux ou trois côtés, également pour des dimensions rectangulaires.

Fixed panel for combinations
to form 2 or 3 sides shower enclosures, also in rectangular sizes.

Panel fijo para combinaciones
combinaciones posibles para la formación de cabinas de ducha de dos o tres lados, también en medidas rectangulares.

Festwand für Kombinationen
mit Türen oder Eckeinstiegen, zur Gestaltung von gleich- oder ungleichschenkligen U- oder L-förmigen Duschkabinen.

Vaste wand voor samenstellingen
van twee of driezijdige douchezellen, mogelijkheid tot rechthoekige maten.

Стационарная панель для комбинирования
с душевыми кабинами. Можно создать душевые кабины с двумя или тремя сторонами, а также с прямоугольными размерами.



H 185 cm. - V 3 mm.

Finitura profili

Finitions des profilés_Profiles finishing _Acabado perfiles
Profilfarbe_Profil afwerkingen_Отделка профилей

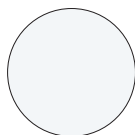

**L01
bianco**
blanc
white
blanco
Weiß
wit
белый

Finitura pannelli

Finitions des panneaux_Panels finishing _Acabado perfiles
Glasart_Paneel afwerkingen_Отделка панелей



**TR
trasparente**
transparent
transparent
transparente
Klarglas
transparent
прозрачное



**ST
Stampato**
granité
frosté
estampado
Bedrucktes Glas
gemarteld
узорчатое



**JU
Juta**
Juta
Juta
Juta
Juta
Juta

Parete fissa per abbinamenti



Paroi fixe pour réaliser des combinaisons Fixed panel for combinations

Panel fijo para combinaciones.

Festwand für Kombinationen

Vaste wand voor samenstellingen

Стационарная панель для комбинирования

Z [cm]	Cod.	A [cm]	B [cm]	C [cm]	 [dm ³]	 [kg]	 [n°]
68-76	B6819	//	//	//	140	15	1
						10	1
77-85	B6820	//	//	//	158	17	1
						11	1
86-94	B6821	//	//	//	175	18	1
						12	1

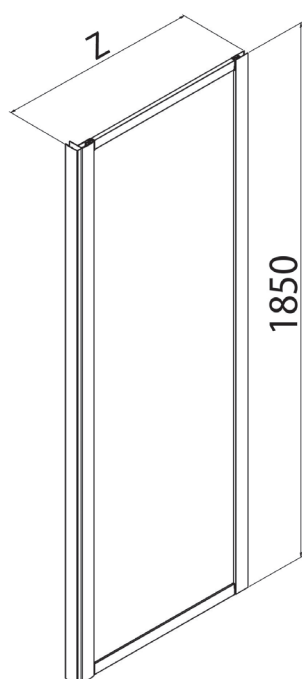
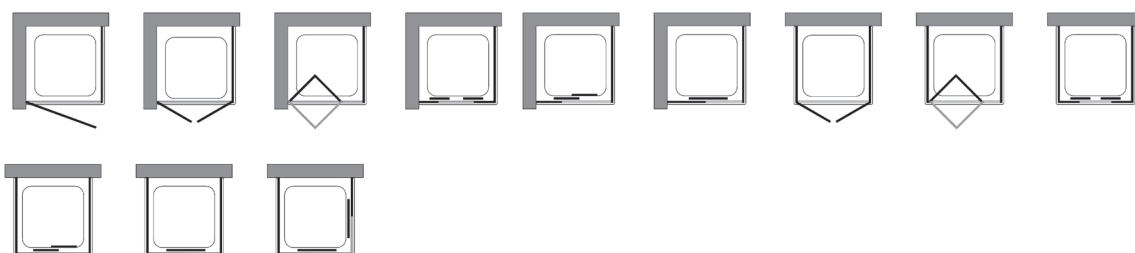

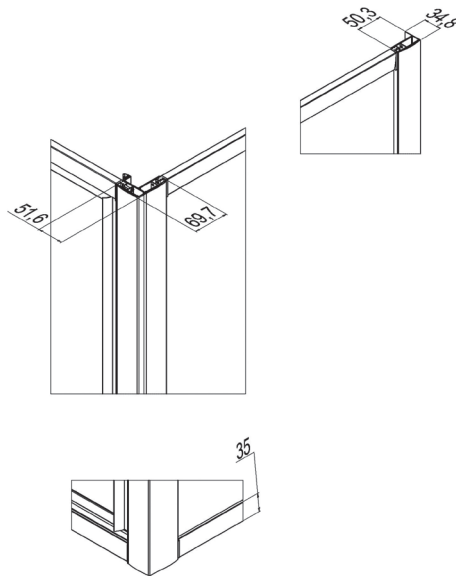
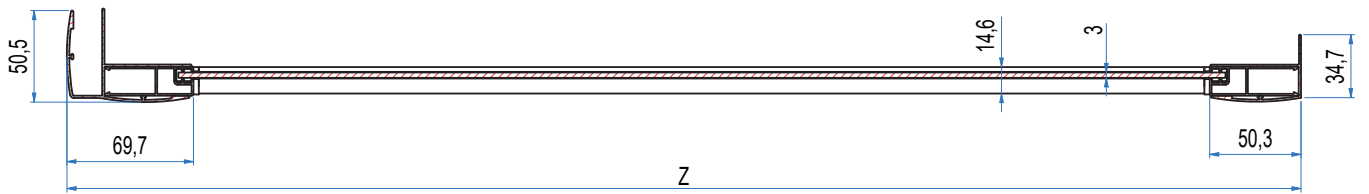

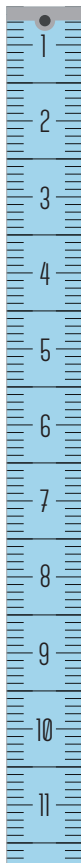

Prodotti Speciali - Produits Spéciaux - Special products - Productos Especiales - Sonderfertigungen - Maatwerk - Специальные Иродукты

MISURE LIMITE	Altezza max 200 cm.	//	Larghezza max 120 cm.	Larghezza min 20 cm.
MESURES LIMITES	Hauteur max 200 cm.	//	Largeur max 120 cm.	Largeur min 20 cm.
LIMITS OF MEASUREMENTS	Height max 200 cm.	//	Width max 120 cm.	Width min 20 cm.
MEDIDAS LIMITE	Altura max 200 cm.	//	Anchura max 120 cm.	Anchura min 20 cm.
GRENZMAßE	Höhe max 200 cm.	//	Breite max 120 cm.	Breite min 20 cm.
EXTREME MATEN	Hoogte max 200 cm.	//	Breedte max 120 cm.	Breedte min 20 cm.
ПРЕДЕЛЬНЫЕ РАЗМЕРЫ:	Макс. высота 200 см	//	Макс. ширина 120 см	Мин. ширина 20 см

	I								
	II								
	III								

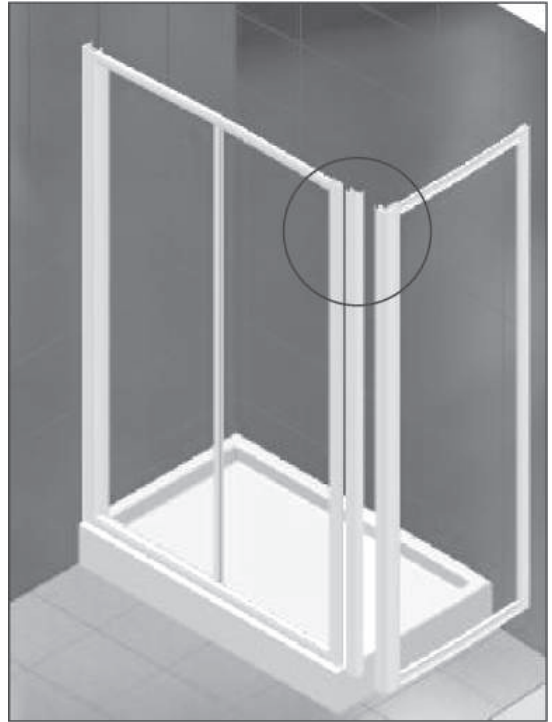
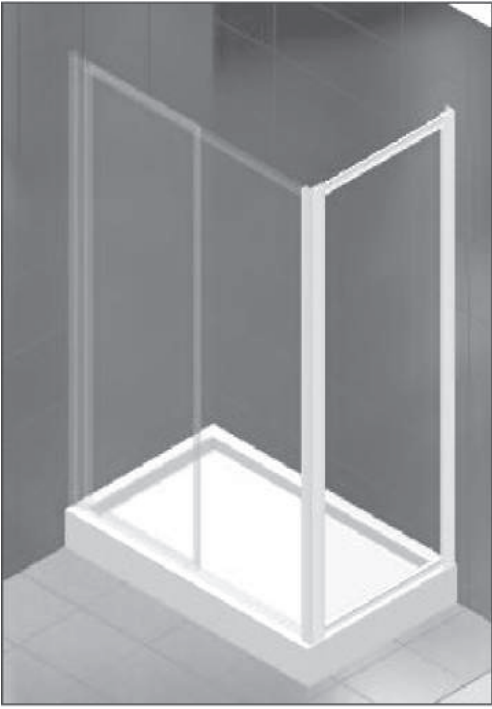

1

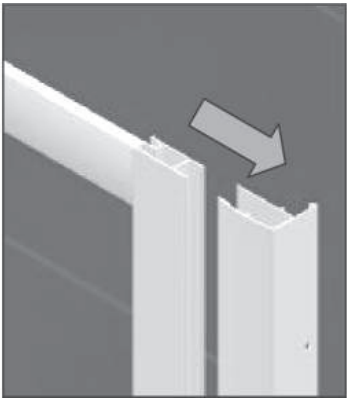

1a

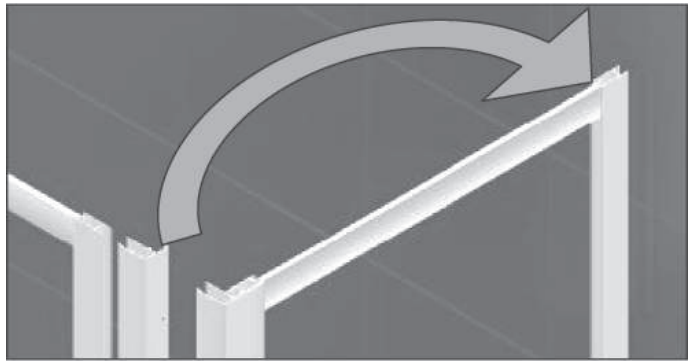

1b

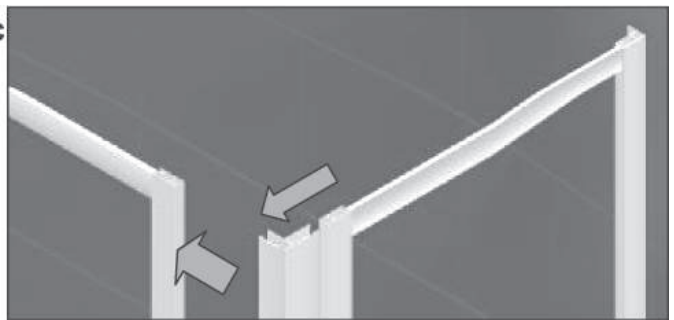

1c

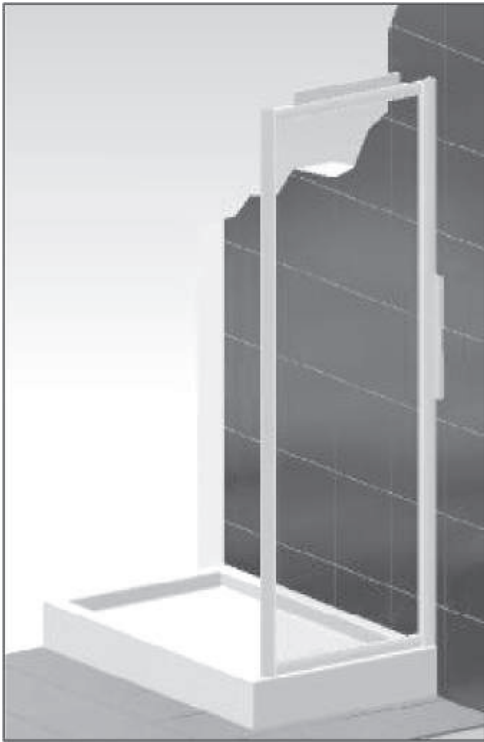

2



3



3a

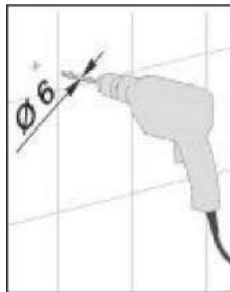

3b



3c

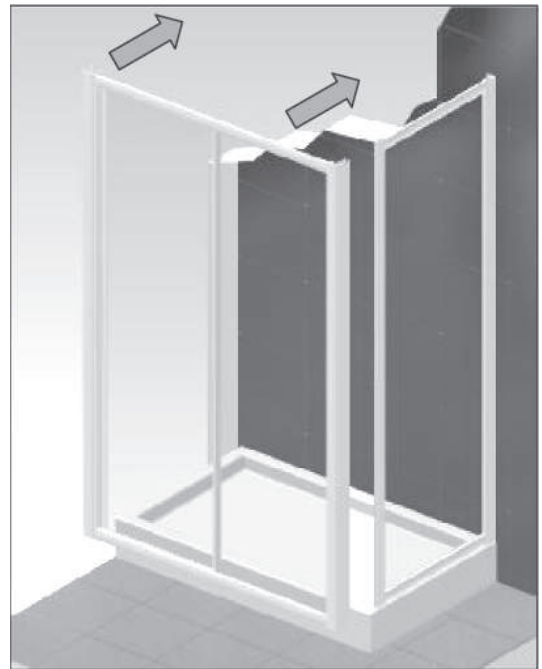

4

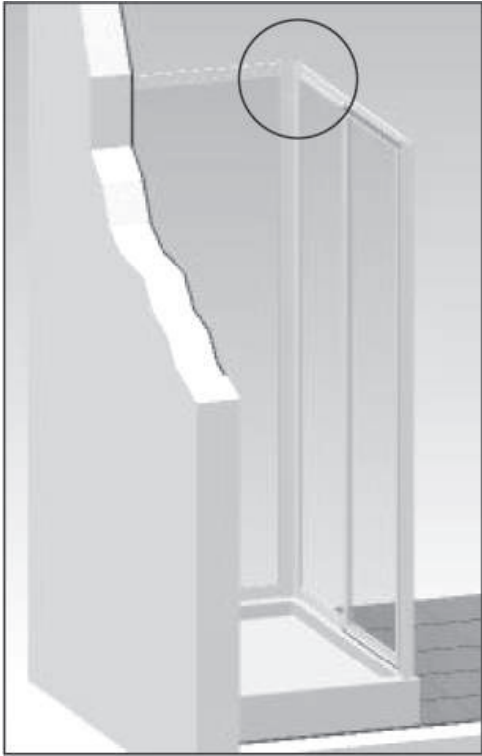

5

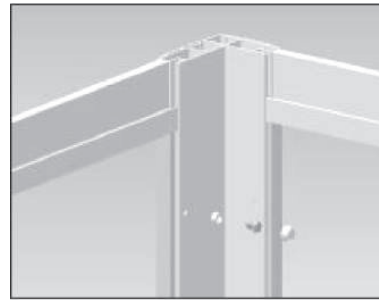

5a

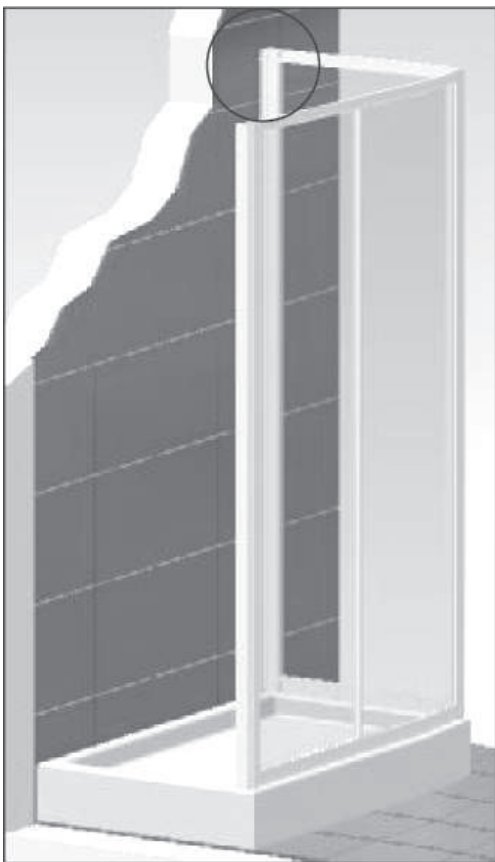

6



6a

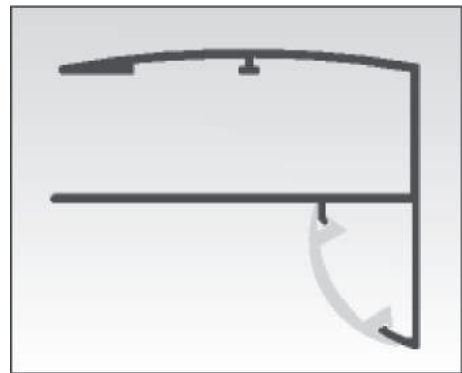

6b