

*RIC1098*

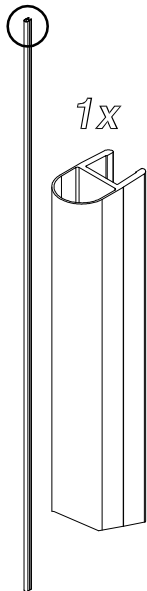

1x

*RIC2350*

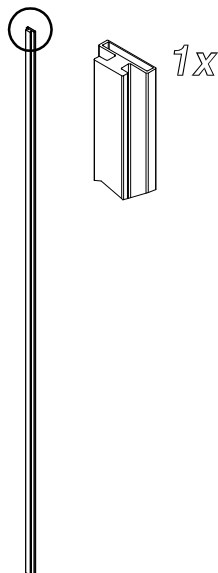

1x

*RIC2353*

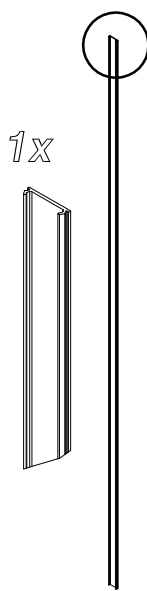

1x

*RIC2364*

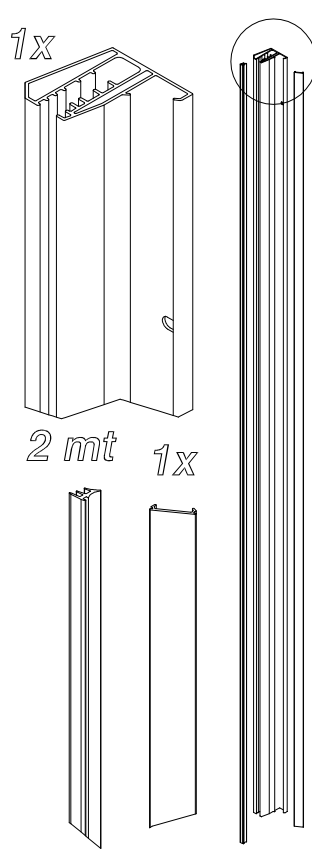

1x

2 mt 1x

*RIC2365*

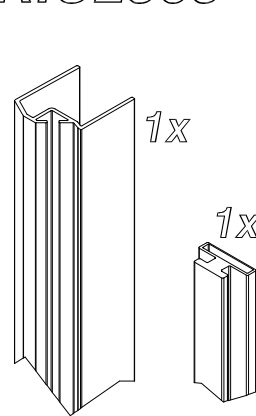

1x

1x

*RIC2366*

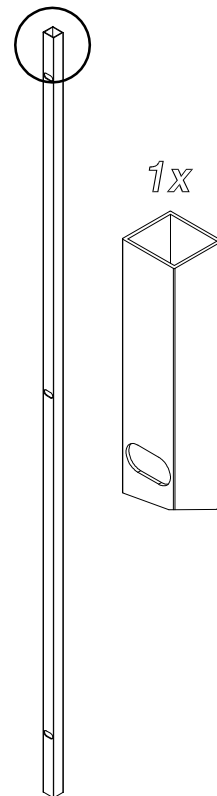

1x

*RIC2368*

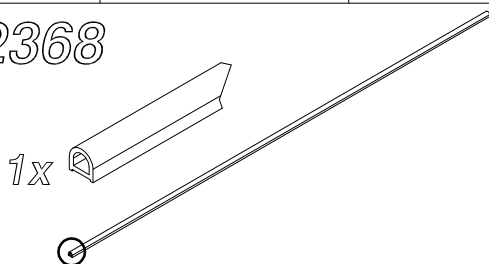

1x

*RIC2351*

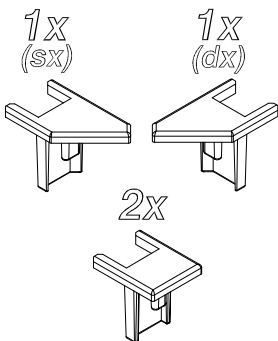

1x (sx)

1x (dx)

2x

*RIC2352*

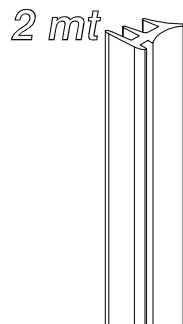

2 mt

*RIC1799*

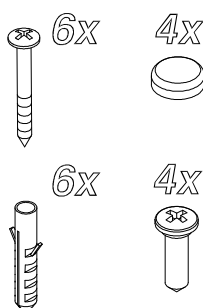

6x

4x

6x

4x

*RIC2355*

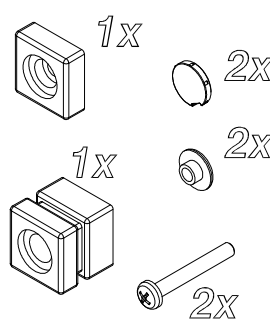

1x

2x

2x

1x

2x

*RIC2356*

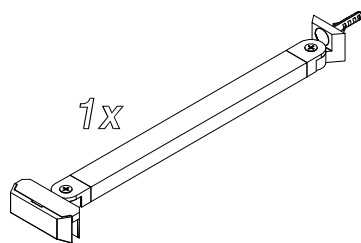

1x

*RIC2361*

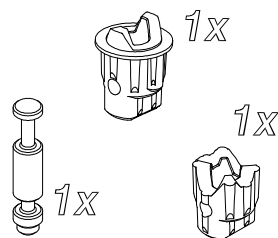

1x

1x

1x

*RIC2362*

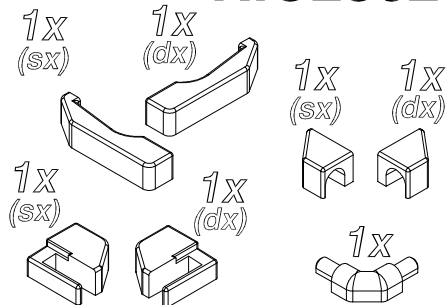

1x (sx)

1x (dx)

1x (sx)

1x (dx)

1x (sx)

1x (dx)

1x

*RIC2363*

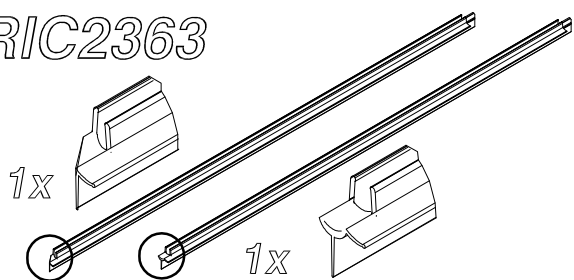

1x

1x

*RIC2360*

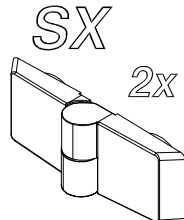

2x

*RIC2359*

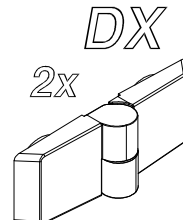

2x

*RIC2354*

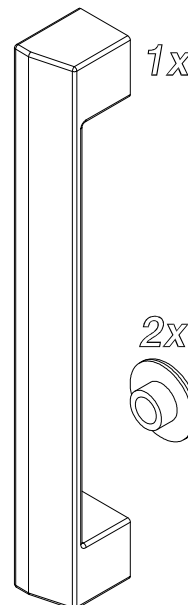

1x

2x